

**KEITHLEY**

---

**MODEL 228A**  
**Voltage/Current Source**

---

**QUICK REFERENCE GUIDE**

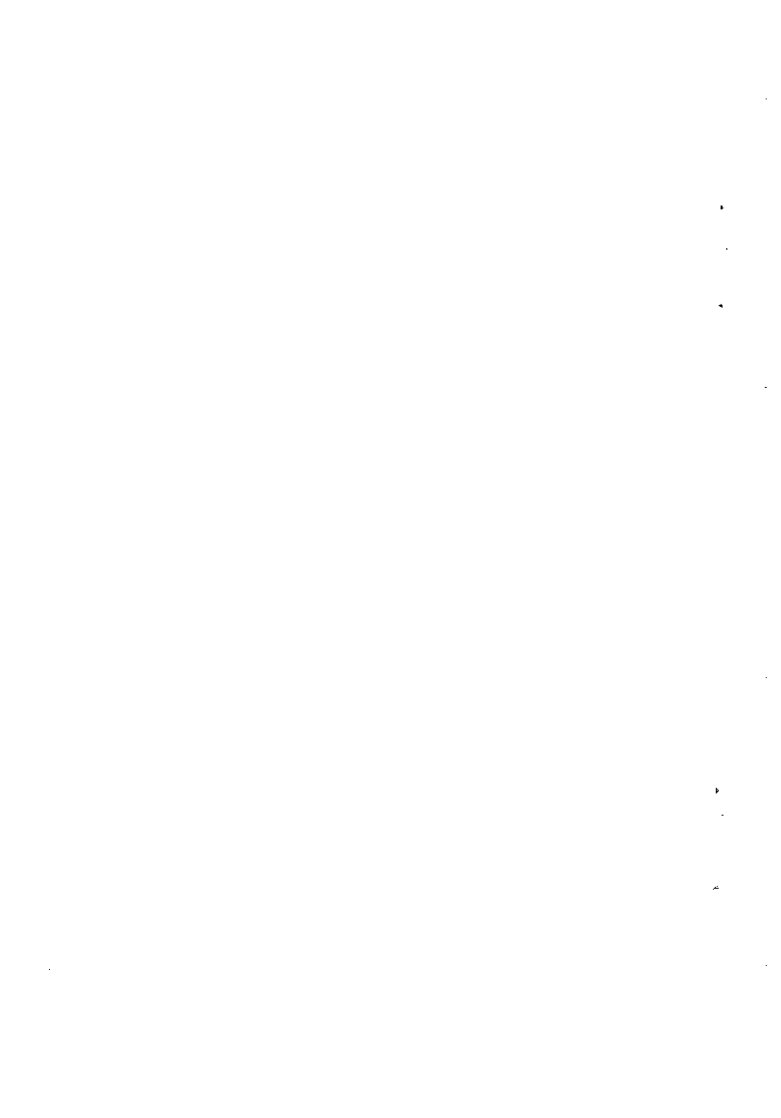

# **INTRODUCTION**

---

This reference and programming guide contains condensed specifications, descriptions of the various features and IEEE-488 programming information.

Included with descriptions of each feature are brief operating instructions and some examples of typical uses.

Included with the programming information are several example programs using some commonly used controllers.

# CONTENTS

---

CONDENSED SPECIFICATIONS .....	3
FRONT PANEL FEATURES .....	7
FRONT PANEL OPERATIONS .....	22
FRONT PANEL PROGRAMS .....	25
REAR PANEL FEATURES .....	30
IEEE-488 PROGRAMMING .....	37
PROGRAMS .....	42
IBM PC or XT .....	43
Apple II .....	45
HP 85 .....	47
HP 9825A .....	48
HP 9816 .....	49
DEC LSI 11 .....	50
PET/CBM 2001 .....	52

# CONDENSED SPECIFICATIONS

## AS A CONSTANT VOLTAGE SOURCE

RANGE	OUTPUT		COMPLIANCE	
			(Source or Sink)	
	MAXI-MUM	ACCURACY* (1 YEAR) 18°-28°C	MAXI-MUM	ACCURACY (1 YEAR) 18°-28°C
100V	±101.0V	±(0.1% + 0.1 V)	±1.010 A ±0.1010A	±(0.1% + 4mA) ±(0.1% + 400 µA)
10V	±10.10V	±(0.1% + 10mV)	±10.10 A ±1.010 A ±0.1010A	±(0.5% + 40mA) ±(0.1% + 4mA) ±(0.1% + 400 µA)
1V	±1.010V	±(0.1% + 1.0mV)	±10.10 A ±1.010 A ±0.1010A	±(0.5% + 40mA) ±(0.1% + 4mA) ±(0.1% + 400 µA)

\*Above 0.4% of range.

**TEMPERATURE COEFFICIENT (0°-18°C & 28°-50°C):** ±(0.1 × applicable accuracy specification)/°C.

NOISE:	RANGE	0.1-300Hz	0.1-300kHz	0.1-20MHz
	100V	5.0mV p-p	15mV p-p	25mV p-p
	10V	2.0mV p-p	15mV p-p	25mV p-p
	1V	0.7mV p-p	15mV p-p	25mV p-p

**OUTPUT RESISTANCE (max):** 100V Range: 10mΩ. 10V Range: 100µΩ.  
1V Range: 100µΩ.

**OUTPUT INDUCTANCE:** 100µH typical.

## AS A CONSTANT CURRENT SOURCE

RANGE	OUTPUT (1 YR., 18°-28°C)		COMPLIANCE	
			(Source or Sink)	
	MAXI-MUM	ACCURACY* (1 YEAR) 18°-28°C	MAXI-MUM	ACCURACY (1 YEAR) 18°-28°C
10 A	±10.10 A	±(0.5% + 10mA)	±10.10V ±1.010V	±(0.1% + 40mV) ±(0.1% + 4mV)
1 A	±1.010 A	±(0.1% + 1.0mA)	±101.0V ±10.10V ±1.010V	±(0.1% + 400mV) ±(0.1% + 40mV) ±(0.1% + 4mV)
0.1A	±0.1010A	±(0.1% + 0.1mA)	±101.0V ±10.10V ±1.010V	±(0.1% + 400mV) ±(0.1% + 40mV) ±(0.1% + 4mV)

\*Above 0.4% of range.

**TEMPERATURE COEFFICIENT (0°-18°C & 28°-50°C):**  $\pm(0.1 \times \text{Applicable accuracy specification})/^\circ\text{C}$ .

NOISE:	RANGE	0.1-300Hz	0.1-300kHz	0.1-20MHz
	10 A	25 mA p-p	25mA p-p	25mA p-p
	1 A	5 mA p-p	5mA p-p	10mA p-p
	0.1A	0.5mA p-p	2mA p-p	3mA p-p

**OUTPUT RESISTANCE (min):** 10A Range: 10 $\Omega$ . 1A Range: 10 $\Omega$ . 0.1A Range: 10 $\Omega$ .

**OUTPUT CAPACITANCE:** 0.2 $\mu$ F typical.

## CURRENT MONITOR OUTPUT

**SCALE FACTOR:** 1V = 100% of range.

**ACCURACY:** Same as constant current mode.

**BANDWIDTH:** 5kHz typical.

**OUTPUT RESISTANCE:** 10k $\Omega$ .

## EXTERNAL MODULATION

**INPUT RESISTANCE:** 6.8k $\Omega$ .

**SENSITIVITY:** -10V increases magnitude of programmed output by 100% of full scale; +10V decreases magnitude of programmed output by 100% of full scale.

**ACCURACY:** 2% typical, dc to 60Hz.

**MAXIMUM MODULATION:** Modulation and programmed setting should not cause operation exceeding the range of zero to 101% of full scale.

**MODULATION FREQUENCY:** 600Hz bandwidth.

## GENERAL

**LINE REGULATION:** Less than 0.01% output change for ac power line changes within specified limits.

**PROGRAM MEMORY (battery backed up):** Stores up to 100 output settings. Range of Dwell Times: 20ms to 1000s. Accuracy of Dwell Times:  $\pm (0.05\% + 2\text{ms})$ .

**RESPONSE TIME:** 30ms max. to 99% of programmed change.

**MAXIMUM COMMON MODE VOLTAGE (output or output common to chassis):** 100V dc.

**WARMUP:** 10 minutes to rated accuracy.

**POWER:** 105-125 or 210-250 V ac (internally switch selectable), 50 or 60Hz, 500 VA maximum.

**ENVIRONMENTAL:** **Operating:** 0° to 50°C, less than 80% non-condensing RH below 35°C. **Storage:** -25° to 70°C.

# **SAFETY PRECAUTIONS**

1. Before operation, ground the instrument through a properly earth grounded power receptacle.
2. Before servicing, disconnect the instrument from line power, all other equipment and consult the Model 228 Instruction Manual.
3. Do not touch the rear panel terminals while the instrument is turned on or connected to any other test equipment. Common mode voltage and programmed output levels may be present.
4. Do not operate the instrument with the top cover and/or bottom cover removed. Lethal potentials are present throughout the main-frame.
5. Observe proper polarity when operating in the sink mode. A reversed polarity may allow the instrument to operate at a current limit of the output fuse.
6. Do not leave the instrument unattended when it is in the operate mode. Always place the instrument in the standby mode after the measurement or test is completed.
7. Always set up the test circuit while the power is turned off. Do not come into contact with any part of the test circuit while power is on.
8. Never assume the output is at a safe potential while AC line power is connected.



# POWER UP SEQUENCE

1. Display Test--The Model 228 display segments and front panel LEDs are lit. This allows the operator to note inoperative display segments or LEDs.
2. RAM Test--The Model 228 performs a digital test on the RAM circuitry. If the RAM test fails, the display locks up with the following message:



3. ROM Test--The Model 228 performs a cyclic redundancy check (CRC) on the ROM circuitry. If the ROM test fails, the display locks up with the following message:

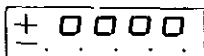
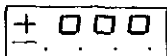

4. Software Revision Level--The following message will be displayed using software revision level A1 as an example:

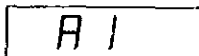
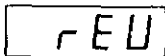

5. IEEE Address--The following message will be displayed using the factory set address 11 as an example:

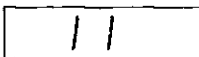
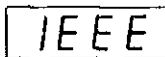

6. Autocalibration--The Model 228 displays the following message and counts down to CAL 00 while performing autocalibration.

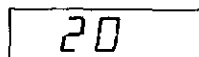
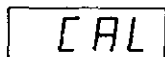

# DISPLAY MESSAGES

The following messages are listed to flag errors or conditions as they occur.

LEFT DISPLAY	RIGHT DISPLAY	DESCRIPTION
+5	Err	+5V Analog supply out of spec.
-5	Err	-5V Analog supply out of spec.
+15	Err	+15V Analog supply out of spec.
-15	Err	-15V Analog supply out of spec.
+115	Err	+115V Analog supply out of spec.
-115	Err	-115V Analog supply out of spec.
-50°	Err	Temperature sensor not working.
+90°	Err	Heatsink temperature has passed 90°C.
Sln	on	Causing sink only to turn on.
+100°	Err	Temperature exceeds 100°C. Switching power supply shuts down and front panel locks up. Turn power off to reset.
OFL	OFL	Reading exceeds 1999 counts on any range.
Err	Err	Reading exceeds 1010 count limit or tried to go below zero.
rng	rng	Illegal range combination.
buF	Err	Incorrect data copied from memory buffers.
buF	End	Attempted to copy from location 100 to 101.
CAL	Err1	Voltage DAC gain is out of cal range.
CAL	Err2	Voltage DAC offset is out of cal range.
CAL	Err3	Current DAC gain is out of cal range.
CAL	Err4	Current DAC offset is out of cal range.

no	Pro	Invalid program selected.
no	rn	Not in remote.
no	AdFb	Analog-Digital interface not working.
Ad	Err	A/D converter supplying unexpected reading values.
IEEE	Err	Selected IEEE address greater than 30.
Pro	?	Prompt for program number.
Pro	(Number)	Selected program number displayed.
IEEE	(Address No)	Program 3 message. IEEE address.
rEV	(e.g. A)	Software revision on power up.
CAL		228 is calibrating. Power up and self test message.
U	On	External voltage modulation on.
U	OFF	External voltage modulation off.
I	On	External current modulation on.
I	OFF	External current modulation off.
SIn	On	Sink only mode on.
SIn	OFF	Sink only mode off.
Cop	002	Program 1. Values copied to displayed memory step from previous memory step.

# **STANDBY/OPERATE**

---

## **DESCRIPTION**

This key toggles the Model 228 between standby and operate. In the standby mode the Model 228 output is still active. The standby mode has the same effect as programming the output for the following conditions:

1. 0V + four counts (on the same voltage range, same polarity).
2. 0A + four counts (on the same current range, same polarity).
3. MOD V is off.
4. MOD I is off.

Refer to paragraph 2.3 in the Model 228 Instruction Manual for standby notes.

In the operate mode, the programmed parameters are present on the output.

## VOLTS/MEMORY STEP

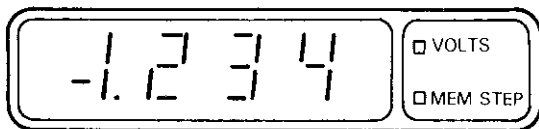

LEFT DISPLAY

### DESCRIPTION

This key toggles the left display between the volts display mode and the memory step display mode. The volts mode displays the programmed voltage setting (or the actual voltage level when in OPERATE) and the memory step mode displays the memory location.

## AMPS/DWELL TIME

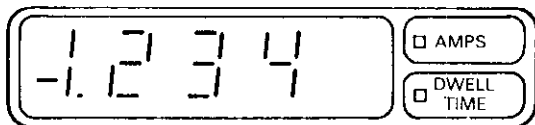

RIGHT DISPLAY

### DESCRIPTION

This key toggles the right display between the amps display mode and the dwell time display mode. The amps mode displays the programmed current setting (or the actual current level when in OPERATE) and the dwell time mode displays the programmed dwell time. Dwell time is defined as the time duration that is spent at a memory location.

The range of dwell time is 20msec to 1000sec.

# DISPLAY MODIFY GROUP

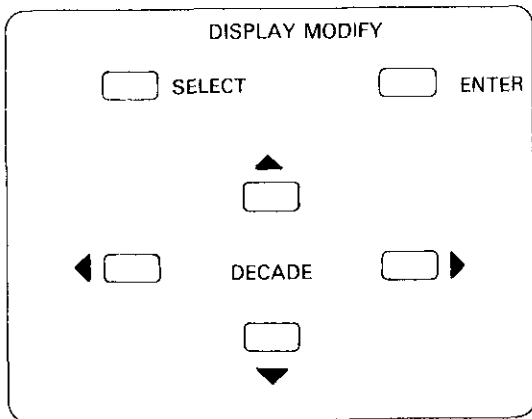

These keys are used to modify the parameters on the two displays.

## **SELECT**

The SELECT key toggles between the left and right displays. The selected display is indicated by the bright digit. If there is no activity on the front panel for approximately 20 seconds, the bright digit returns to normal.

## DECADE

The DECADE keys are used to modify the selected display. The digit select keys (identified by the left and right arrows) select the digit to be modified. The selected digit is the flashing bright digit. The digit modify keys (identified by the up and down arrows) increment or decrement the value of the selected digit. The modified digit has carry and borrow capabilities. The output immediately tracks the modified display.

### NOTE

The DECADE keys will not allow the range or polarity to change. Entering a value outside of 0 to 1010, causes an "Err" message to be displayed. To enter values of a different range use the DATA keys.

## ENTER

The ENTER key is used to exit the modify mode. The ENTER key must be pressed to update the output after the DATA keys are used to modify the display.

# DATA

---

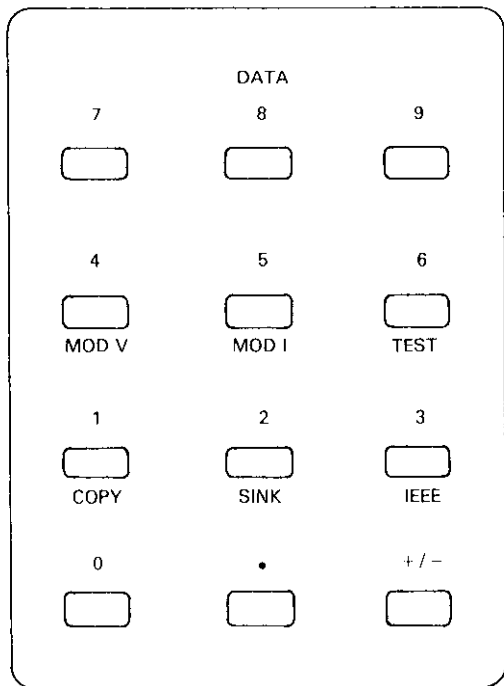

## DESCRIPTION

The DATA keys are used to modify the programmed values. Press the ENTER key after the keystroke sequence is complete. The DATA keys are also used to activate front panel programs.



# MEMORY CONTROL GROUP

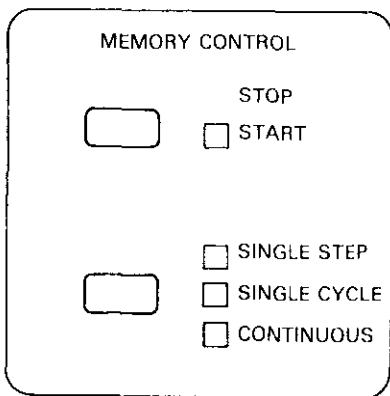

## STOP/START

The START/STOP key serves three functions that are described as follows:

1. When the START/STOP key is pressed the selected memory control mode (single step, single cycle or continuous) is started.
2. Press the START/STOP key while the memory control mode is running stops the memory control mode at the present memory location.
3. In the single step memory control mode, pressing the START/STOP key advances the instrument to the next programmed memory location.

## **SINGLE STEP/SINGLE CYCLE/CONTINUOUS**

This key selects one of the following memory controls:

1. **Single Step**—Allows the user to step through the programmed memory locations one at a time. Every time the STOP/START key is pressed the instrument advances to the next memory location after waiting the programmed dwell time.
2. **Single Cycle**—Allows the user to run through one complete cycle of the programmed memory locations.
3. **Continuous**—Allows the user to run through the programmed memory locations in a continuous loop.

# COMPLIANCE

---

## DESCRIPTION

The compliance LEDs define the following four parameters of the output:

1. Operation as a source or sink.
2. The polarity of the voltage.
3. The polarity of the current.
4. Which function, voltage or current is being controlled.

The following illustration has the LEDs numbered 1 through 8 for the purpose of explaining the significance of each one.

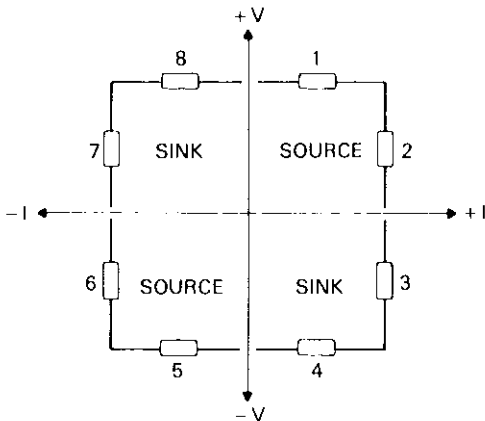

Fig 1. Compliance LEDs

The significance of each compliance LED is as follows:

1. If LED 1 is on, the Model 228 is operating as a source. Voltage and current are positive. Voltage is being controlled.
2. If LED 2 is on, the Model 228 is operating as a source. Voltage and current are positive. Current is being controlled.
3. If LED 3 is on, the Model 228 is operating as a sink. Voltage is negative. Current is positive and being controlled.
4. If LED 4 is on, the Model 228 is operating as a sink. Voltage is negative. Current is positive and voltage is being controlled.
5. If LED 5 is on, the Model 228 is operating as a source. Voltage and current are negative. Voltage is being controlled.
6. If LED 6 is on, the Model 228 is operating as a source. Voltage and current are negative. Current is being controlled.
7. If LED 7 is on, the Model 228 is operating as a sink. Voltage is positive. Current is negative and being controlled.
8. If LED 8 is on then the Model 228 is operating as a sink. Voltage is positive. Current is negative. Voltage is being controlled.

#### NOTE

For more information on sink operation, see SINK MODE.

# STATUS GROUP

---

STATUS	
<input type="checkbox"/> LOCAL	<input type="checkbox"/> REMOTE
<input type="checkbox"/> TALK	<input type="checkbox"/> LISTEN
<input type="checkbox"/> MODULATE I	
<input type="checkbox"/> MODULATE V	
<input type="checkbox"/> SINK ONLY	

## LOCAL

The LOCAL key takes the instrument out of the remote mode (IEEE-488 bus operation) and enables the front panel controls (provided local lockout LLO has not been sent over bus).

## REMOTE/TALK/LISTEN

The indicator lights are functional when the instrument is being controlled over the IEEE-488 bus.

Remote—Indicates that the instrument is in the remote mode. Front panel keys are disabled.

Talk—Indicates that the instrument is in the talk mode.

Listen—Indicates that the instrument is in the listen mode.

## **MODULATE I/MODULATE V**

The appropriate LED is on when the Model 228 is programmed to modulate output current (I) or voltage (V).

## **SINK ONLY**

This LED indicates that the instrument is in the sink only mode. Program 2 places the instrument in the sink mode, but the instrument automatically goes into sink only if internal temperatures exceeds 90°C.

# PROGRAM CONTROL GROUP

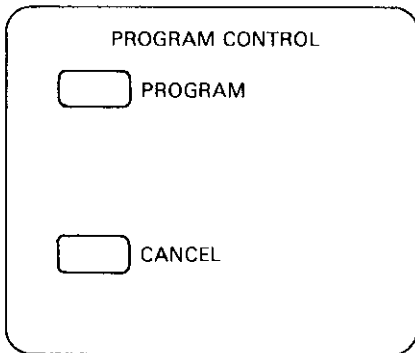

## **PROGRAM**

The PROGRAM key is used along with the DATA keys to select one of seven front panel programs. The program names are located under the corresponding data keys (except for Program 9).

## **CANCEL**

The CANCEL key is used to exit the program mode without changing previously entered program parameters. The instrument returns to the previous operating mode. This key can also be used in the display modify mode. A display that is incorrectly modified (but not entered) using the DATA keys, can be cleared by pressing the CANCEL key.

# **FRONT PANEL OPERATION**

## **DESCRIPTION**

The Model 228 can be configured to source or sink electrical power. As a sink, the instrument is operating as an active load that dissipates power. In addition to programming each memory step for voltage, current and dwell time, external modulation and sink only can also be programmed for each step.

## **SOURCE MODE**

The Model 228 operates as a source when its output is connected to a passive load, such as a resistor. However, the Model 228 will also operate as a source when the output is connected to an external voltage source. As long as the programmed output voltage of the Model 228 exceeds the voltage of the external source, it is operating as a source.

### **CAUTION**

**If an external source is used, the polarity of it and the Model 228 must be the same in order for current limiting to work. Otherwise, the output fuse (20A) is the current limit.**

## **SINK MODE**

The Model 228 operates as a sink whenever its output is connected to a voltage source that exceeds the programmed output voltage of the instrument. As a sink, the instrument operates as an active load rather than a source. Do not exceed the power dissipation limits defined by the recommended operating limits.

If the instrument is operating near the maximum dissipation limit causing internal temperatures to exceed 90°C, Program 2 will activate as indicated by the SINK ONLY LED being on. The instrument should not be operated as a source when in this mode since current will be limited at approximately 1.5A.



### CAUTION

During the sink mode of operation, the Model 228 and the external source must have the same voltage polarity in order for current limiting to operate. Otherwise, the output fuse (20A) is the current limit.

## OPERATION

The following instructions assume that the user has already become familiar with the front panel features discussed previously. Before performing the following procedure, make sure the instrument is in standby mode.

1. Modify the left display as follows:
  - A. Select the left display by pressing the SELECT key until the bright digit is displayed.
  - B. Set the display to the memory step mode by pressing the VOLTS/MEMORY STEP key until the MEM STEP LED turns on.
  - C. Enter the first memory location (001) using either the DECADE or DATA keys. If the DATA keys are used, the ENTER key must be pressed after the memory step mode is activated.

### NOTE

Decade key cannot increment or decrement past a range limit or zero.

- D. Set the display to the volts mode by pressing the VOLTS/MEMORY STEP key.
  - E. Enter the desired voltage level using either the DECADE or DATA keys. If the DATA keys are used, remember to press ENTER.
2. Modify the right display as follows:
  - A. Select the right display by pressing the SELECT key until the bright digit is displayed.
  - B. Set the display to the current mode by pressing the AMPS/DWELL TIME key until the AMPS LED turns on.
  - C. Enter the desired current level using either the DECADE or DATA keys.

- D. Set the display to the dwell time mode by pressing the AMPS/DWELL TIME key.
- E. Enter the desired dwell time using either the DECADE or DATA keys.
3. If modulation and/or sink only is wanted in this memory location, select the appropriate front panel programs.
4. Repeat steps 1 through 3 to program for each desired memory location. There are 100 possible locations.
5. If less than 100 memory locations are used, program the first unused memory location for a dwell time of zero. This will keep the instrument from operating in an unwanted memory location.

#### **NOTE**

After the memory locations are programmed, check over each one. To do so, use the single step feature.

6. With memory control stopped (MEMORY CONTROL LED off), select the desired control mode: single step, single cycle or continuous.
7. Set the left display to the first memory location.
8. Connect the load or source to the output terminals on the quick disconnect board.
9. Place the instrument in operate mode. The voltage and current programmed in the first memory location will be available on the output.
10. Start the memory control by pressing the MEMORY CONTROL key (MEMORY CONTROL LED on).

#### **NOTE**

In the operate mode, the volts and amps displays will display the operating levels rather than the programmed levels. For example, if 5V and 0.500A are programmed and the load is drawing 125mA; then the current display reads 0.125A. The same is true for the volts display.

# **FRONT PANEL PROGRAMS**

## **DESCRIPTION**

To select a program, press the appropriate PROGRAM and DATA key. All Program names are listed below the corresponding DATA key (except for Program 9).

## **PROGRAM 1 COPY**

### **DESCRIPTION**

Program 1 is used to duplicate the voltage, current, dwell time, MOD V, MOD I and sink only of the current memory location into the next memory location. This program is useful when one or two of the five parameters required are constant. The variable parameter is the only one that needs to be programmed for each memory location.

### **OPERATION**

1. With the instrument in standby mode, select the first memory location.
2. Program the voltage, current and dwell time at this location.
3. Select Program 1. Values are copied to the second (displayed) memory location.
4. To place the data in the third memory location, again select Program 1.
5. Continue selecting Program 1 as many times as needed (up to 100 memory locations).
6. If less than 100 memory locations are used, program the first unused memory location for a dwell time of zero. This will keep the instrument from operating in an unwanted memory location.
7. Return to first memory location and reprogram parameter to be varied.
8. Programming is now complete. Operate the instrument as outlined in Front Panel Operation steps 5 through 10.

# PROGRAM 2 SINK ONLY

## DESCRIPTION

Program 2 decreases the high power, internal supply so that as a sink (active load) the instrument can dissipate full power continuously at 50°C ambient with no derating. The Model 228 should only be used as an active load when in this mode.

## OPERATION

1. Select Program 2. After the message "SIn on" is displayed, the SINK ONLY LED will turn on.
2. To disable sink only, again select Program 2. After the message "SIn oFF" is displayed, the SINK ONLY LED will turn off.

### NOTE

The instrument will go into sink only automatically if it is used to sink power levels near the maximum specified rating (100W) and internal temperatures exceed 90°C.

For voltages below 5V, Program 2 is not required and may prevent the Model 228 from sinking voltages close to zero volts.

# PROGRAM 3 IEEE

## DESCRIPTION

This program is used to set the primary address of the Model 228 for IEEE-488 bus operation. The primary address of the Model 228 is set at the factory to 11, but it may be set to any value between 0 and 30. Make sure to avoid address conflicts with other equipment. The primary address is battery backed up and therefore not affected by turning off power.

## OPERATION

1. Select Program 3. The message "IEEE" and the current address will be displayed.
2. Enter the desired address using the DATA keys and then press the ENTER key.
3. Verify that the address changed by again selecting Program 3.
4. Exit the program mode by pressing either the CANCEL key or the ENTER key.

## PROGRAM 4 MOD V

### DESCRIPTION

Program 4 is used to modulate the output voltage by allowing a signal to be superimposed on it. A  $\pm 10V$  signal applied produces  $\mp$  full range output. Make sure the instrument is in standby before proceeding. The output is limited by zero and 100% of full scale output.

### OPERATION

#### WARNING

**Programmed DC plus peak modulated voltage should not exceed 101% of range or cause a change in output polarity.**

1. Select the desired memory step.
2. Select Program 4. The MODULATE V LED will turn on.
3. Connect the modulating signal to the external modulation terminals located on the quick disconnect board. The output is limited by zero and 100% full scale output.

# PROGRAM 5 MOD I

## DESCRIPTION

Program 5 is used to modulate the output current by allowing a signal to be superimposed on it. A  $\pm 10V$  signal applied produces  $\mp$  full range output. Make sure the instrument is in standby.

## OPERATION

### WARNING

**Programmed DC plus peak modulated voltage should not exceed 101% of range or cause a change in output polarity.**

1. Select the desired memory step.
2. Select Program 5. The MODULATE I LED will turn on.
3. Connect the modulating signal to the external modulation terminals located on the quick disconnect board.

# PROGRAM 6 TEST

## DESCRIPTION

Program 6 is used to test ROM, RAM and the front panel LEDs, perform an autocalibration on the analog circuitry, display the IEEE address and the software revision level. This program also runs during power up.

## OPERATION

1. Select Program 6.
2. Refer to the power up sequence for an explanation of the test sequence.

3. The instrument will exit from the program after successfully completing the test program.

## **PROGRAM 9 RESET**

### **DESCRIPTION**

Program 9 is used to reset the Model 228 to the factory conditions. These conditions are the same as the device clear (SDC or DCL) command with one exception. The exception is that all of the programmed *memory locations are cleared of all previous data.*

### **OPERATION**

1. Select Program 9.
2. The Model 228 runs through the reset sequence as described in the power up sequence.
3. Once the VOLTS and AMPS displays show zero, the Model 228 is reset to factory conditions.

# QUICK DISCONNECT

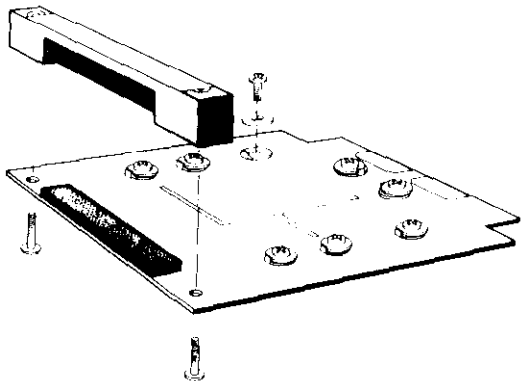

## DESCRIPTION

The Model 228 output, sense, modulation and current terminals are located on a quick disconnect board. Cables (up to 16 AWG wire) can be connected to the screw type terminals on the board using insulated lugs. Once the board is plugged into the appropriate slot in the rear panel, the terminals are inaccessible, thus eliminating a shock hazard.

### CAUTION

When an external source is connected to this card, care must be taken to:

Prevent contact with the connections when the card is not installed.

Prevent shorting the contacts to the metal rear panel while installing the card.



# SENSE

---

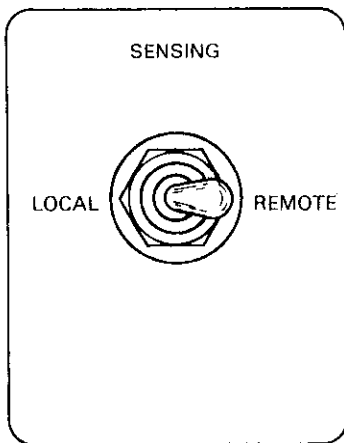

## DESCRIPTION

The toggle switch on the rear panel is used to select local or remote sensing. In the local sense mode, regulation is maintained at the output terminals on the quick disconnect board. In the remote sensing mode, regulation is provided at the load and compensates for the IR drop of the output cables.

## OPERATION

To configure local sense, set the SENSE switch to the LOCAL position.

To configure remote sense:

1. Set the SENSE switch to the REMOTE position.
2. Connect a sense cable from the S+ terminal, on the quick disconnect board, to the OUT + connection at the load.
3. Connect a sense cable from the S- terminal to the OUT - connection at the load.
4. Refer to safety precautions at the front of this document.

### NOTE

The maximum resistance per lead is  $5\Omega$  for rated accuracy. The maximum lead (IR) drop per lead is 0.5V.

### WARNING

**Improper sense lead connection may cause dangerous voltage to be present on the output terminals.**

# I MONITOR

---

## DESCRIPTION

A voltage level that is proportional to the current level can be monitored using the current monitor output. All current ranges output 1V at full scale (100% of range). The accuracy of the current monitor is the same as the *constant current mode*. The current monitor is not connected to the 3½ digit A/D converter and therefore has a higher resolution than the front panel display. The current monitor readings may be read back over the IEEE-488 bus, eliminating the need for external metering.

The bandwidth of the current monitor is 5kHz (typical). The output resistance is 10k $\Omega$ . The current monitor terminals are located on the quick disconnect board.

# TRIGGER (IN and OUT)

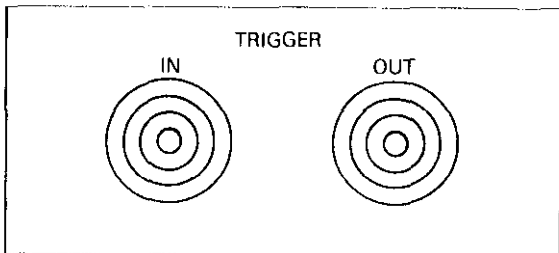

## DESCRIPTION

A TTL level negative going pulse of greater than  $10\mu\text{sec}$  applied to the rear panel TRIGGER IN connector initiates the selected memory control mode (single step, single cycle or continuous). To output any programmed values the memory control must be selected, the OPERATE key enabled and the proper external trigger pulse must be applied to the TRIGGER IN connector.

The resulting trigger output is a TTL level negative going pulse, greater than  $10\mu\text{sec}$ , that signifies the completion of a programmed dwell time. The pulse appears at the rear panel TRIGGER OUT connector at the end of the programmed dwell time in all three memory control modes. There is an output pulse at the end of every programmed dwell time. In the single step mode, the next memory location is selected and a pulse is output at the end of its dwell time. To go to the next memory location and output a pulse, apply another trigger input pulse.

## TYPICAL USE

The Model 228 and a DMM with similar trigger capabilities can be used together to form a mini system without the use of a controller. When the memory control of a programmed Model 228 is started, a trigger pulse will be sent to the DMM at the end of the first dwell time. The DMM will then take a reading and send a trigger pulse back to the Model 228 to output the next memory location. This process will continue until stopped.

Program the Model 228 to the single step mode. Press the START/STOP key to start the process. The CANCEL key must be held in until the Model 228 begins a dwell time to prevent the trigger from a DMM from restarting the process.

# FUSES

## DESCRIPTION

All of the fuses used in the Model 228 are accessible from the rear panel. Replace fuses with the appropriate type using the following tables as a guide.

### CAUTION

Do not use a fuse with a rating higher than specified or instrument damage may occur.

MODEL	LINE VOLTAGE SELECTED	TYPE	RATING	KEITHLEY P/N
<b>USA</b>				
Output Fuse	—	Normal Blo, Ceramic Body	250V, 20A	FU-47
Line Fuse 1	105-125V	Normal-Blo, 3AG	250V, 5A	FU-64
	210-250V	Normal-Blo, 3AG	250V, 2.5A	FU-66
Line Fuse 2	105-125V	Slo-Blo, MDL	250V, $\frac{1}{2}$ A	FU-19
	210-250V	Slo-Blo, MDL	250V, $\frac{1}{2}$ A	FU-18
<b>EUROPEAN</b>				
Output Fuse	—	Normal-Blo, 5 × 20mm	250V, 20A	FU-68
Line Fuse 1	105-125V	Normal-Blo, 5 × 20mm	250V, 5A	FU-65
	205-250V	Normal-Blo, 5 × 20mm	250V, 2.5A	FU-67
Line Fuse 2	105-125V	Slo-Blo, 5 × 20mm	250V, $\frac{1}{10}$ A	FU-52
	210-250V	Slo-Blo, 5 × 20mm	250V, $\frac{1}{10}$ A	FU-53

# IEEE-488 PROGRAMMING

---

This section briefly describes Model 228 operation over the IEEE-488 bus. All of the device dependent commands are listed. Several example programs using some commonly used controllers are outlined to get the Model 228 "up and running". More detailed information and programming examples are listed in the Model 228 Instruction Manual.

DISPLAY:	LEFT DISPLAY D0 = VOLTS D1 = MEM STEP D2 = VOLTS D3 = MEM STEP D4 = Display Message Mode RIGHT DISPLAY D0 = AMPS D1 = AMPS D2 = SECONDS D3 = SECONDS D4 = Display Message Mode
FUNCTION:	F0 = Standby (Outputs approximately + four counts on same range. F1 = Operate
DATA FORMAT:	G0 = Send contents of buffer location with prefix. G1 = Send contents of buffer location without prefix. G2 = Send contents of full buffer with prefix. G3 = Send contents of full buffer without prefix. G4 = Send volts and amps readings with prefix. G5 = Send volts and amps readings without prefix.

EOL:	<p>K0 = Send EOI with last byte; hold off bus on X.</p> <p>K1 = Do not send EOI with last byte; hold off bus on X.</p> <p>K2 = Send EOI with last byte; do not hold off bus on X.</p> <p>K3 = Do not send EOI with last byte; do not hold off bus on X.</p>
SRQ:	<p>M0 = Clear SRQ mask</p> <p>M1 = Ready</p> <p>M2 = Error (IDDC, IDDCO or No Remote)</p> <p>M4 = End of Buffer</p> <p>M8 = End of Dwell Time</p>
MEMORY CONTROL:	<p>P0 = Single Step</p> <p>P1 = Single Cycle</p> <p>P2 = Continuous</p>
RANGE:	<p>R0 = Autorange</p> <p>R1 = 1V, 100mA</p> <p>R2 = 1V, 1A</p> <p>R3 = 1V, 10A</p> <p>R4 = 10V, 100mA</p> <p>R5 = 10V, 1A</p> <p>R6 = 10V, 10A</p> <p>R7 = 100V, 100mA</p> <p>R8 = 100V, 1A</p>
EXTERNAL MODULATION:	<p>A0 = Turn off voltage modulation.</p> <p>A1 = Turn on voltage modulation.</p> <p>C0 = Turn off current modulation.</p> <p>C1 = Turn on current modulation.</p>
TRIGGER:	<p>T0 = Start on TALK</p> <p>T1 = Stop on TALK</p> <p>T2 = Start on GET</p> <p>T3 = Stop on GET</p> <p>T4 = Start on X</p> <p>T5 = Stop on X</p> <p>T6 = Start on External Trigger</p> <p>T7 = Stop on External Trigger</p>



INPUTS:	V = Voltage I = Current W = Dwell Time B = Memory Location
SINK ONLY:	S0 = Sink Only off S1 = Sink Only on
STATUS:	U0 = Send Machine Status Word U1 = Send Error Status Word Note: Even G mode sends prefix; odd G mode suppress prefix.
EXECUTE:	X = Execute device-dependent commands.
SELF TEST:	J0 = Run Self Test Note: J0 in Machine Status Word = J0 not sent J1 in Machine Status Word = Self Test passed J2 in Machine Status Word = Self Test failed
TERMINATOR:	Y(ASCII) Any ASCII character except capitals, numbers, + - / . or e Ym = One Terminator Ymn = Two Terminator Y(X) = None

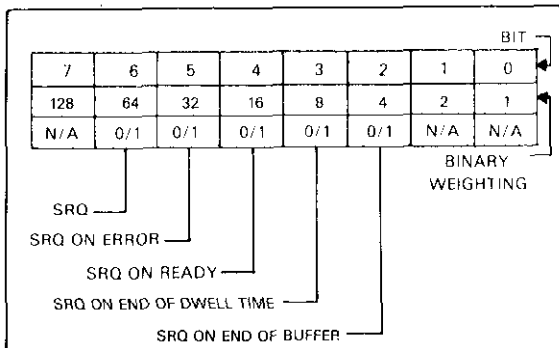

**Fig 2. Machine Status Word**

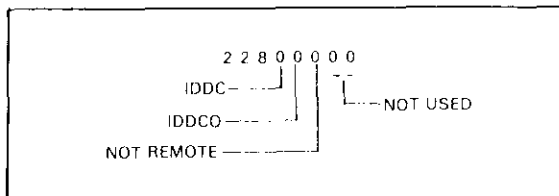

**Fig 3. Error Status Word**

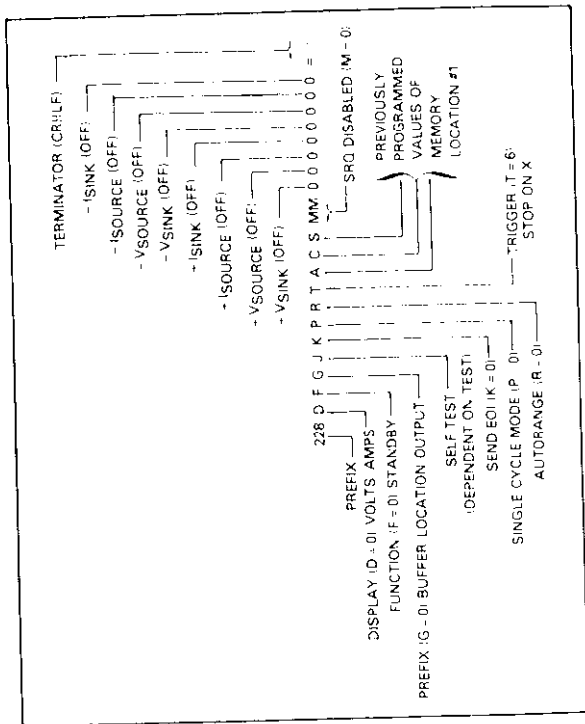

Fig 4. Data Format

# **PROGRAMS**

---

The following programs are designed to be a simple aid to the user. They are not intended to suit specific needs. Detailed programming information can be found in the Model 228 Instruction Manual.

# **IBM PC or XT (Keithley 8573 GPIB Interface)**

---

The following program sends a command string to the Model 228 from an IBM PC or XT computer and displays the instrument data string on the CRT. The computer must be equipped with a Keithley Instruments Model 8573 GPIB IEEE interface and the DOS 2.0 operating system. The GPIB software and hardware must be configured per the Model 8573 Instruction Manual.

## **DIRECTIONS**

1. Using front panel Program 3, set the primary address of the Model 228 to 11.
2. With the power off, connect the Model 228 to the IEEE-488 interface installed in the IBM computer.
3. Type in the command **BASICA** on the IBM keyboard to get into the IBM interpretive **BASICA** language.
4. Place the interface software disc in the default drive, type **LOAD "DECL"**, and press the return key.
5. Enter the following program into the computer, pressing the return key after each line is typed. Lines 1-6 are part of the **DECL** program previously loaded and need not be typed in.
6. Run the program and type in the desired command string when prompted. For example: To program the Model 228 for 1V and 100mA, enter **V1:1X**.
7. The entire reading string from the instrument will then appear on the CRT.
8. To exit the program type **EXIT** and press return.

**PROGRAM****COMMENTS**

---

10 CLS	
20 NA\$=" GPIB0":CALL IBFIND (NA\$,BRD0%)	Find the board number.
30 NA\$=" DEV0":CALL IBFIND (NA\$,M228%)	Find the 228 number.
40 V%= 11:CALL IBPAD (M228%,V%)	Change to primary address 11.
50 V%= 1:CALL IBSRE (BRD0%,V%)	Set REN true.
60 INPUT"COMMAND";CMD\$	Prompt for command string.
70 IF CMD\$="EXIT" THEN 150	See if program is to be halted.
80 IF CMD\$=" " THEN 60	If null command string, go back and get another.
90 CALL IBWRT (M228%,CMD\$)	Address 228 to listen and send command string.
100 RD\$=SPACE\$(65)	Assign reading input buffer.
110 CALL IBRD(M228%,RD\$)	Address 228 to talk and send command string
120 RD\$=LEFT\$(RD\$,IBCNT%)	Trim string to proper size.
130 PRINT RD\$	Display the reading on the CRT.
140 GOTO 60	Repeat.
150 V%=0:CALL IBONL (BRD0%,V%)	Close the board file.
160 CALL IBONL (M228%,V%)	Close the instrument file.
170 END	

---

Note: Lines 1-6 of this program need not be typed in and are not shown here. When the command LOAD"DECL" is entered, lines 1-6 are loaded from the disc into the computer. An address value must be added in place of the "X"s on lines 1 and 2.

# APPLE II

## (APPLE Interface)

---

This program programs the Model 228 according to the current and voltage values entered from the APPLE II keyboard.

### DIRECTIONS

1. Using front panel Program 3, set the primary address of the Model 228 to 11.
2. Connect the Model 228 to the APPLE II and APPLE IEEE-488 interface.
3. Enter the following program using the RETURN key after each line.
4. Type in RUN and depress the RETURN key.
5. The display will read "ENTER I".
6. To program the Model 228 for 100mA, type .1 and press the return key.
7. The display will read "ENTER V".
8. To program the Model 228 for 1V, type 1 and press the return key.
9. The programmed change can be verified by pressing the LOCAL key on the Model 228 and using the front panel controls to read the values.

**PROGRAM****COMMENTS**

---

10 PRINT "ENTER I"	
20 INPUT I\$	Enter desired current (Example: 100mA = .1).
30 PRINT "ENTER V"	
40 INPUT V\$	Enter desired voltage (Example: 1V = 1).
50 Z\$ = CHR\$(26)	Define Z\$ = CTRL-Z.
60 PR#3	Send output to IEEE bus.
70 IN#3	Get input from IEEE bus.
80 PRINT "RA"	Sent remote enable all.
90 PRINT "WT + ,";Z\$;"R0F1X"; "I";I\$;"V";V\$;"X"	Output to IEEE bus, address 11.
100 PRINT "LF1"	Send line feed after carriage return.
110 PR#0	Send to I/O on the CRT and keyboard.
120 IN#0	
130 GO TO 10	
140 END	Repeat

---

Note: If conversion to numeric variable is needed, add the following:

```
134 A = VAL(MID$(A$,5,11))
136 PRINT A
```



# HP 85

---

This program sets up the Model 228 output according to the values entered from the HP-85 keyboard, using the 82973A GPIB interface.

## DIRECTIONS

1. Using Program 3, set the primary address on the Model 228 to 11.
2. Connect the Model 228 to the HP82937A IEEE interface.
3. Enter the following program using the END LINE key after each line is typed.
4. Depress the RUN key.
5. The display will read "ENTER I = "".
6. To program the Model 228 for 100mA, type .1 and press END LINE.
7. The display will read "ENTER V = "".
8. To program the Model 228 for 1V, type 1 and press END LINE.
9. The programmed change can be verified by pressing the LOCAL key and using the front panel controls to read the values.

PROGRAM	COMMENTS
10 REMOTE 711	Set 228 to remote.
20 DISP "ENTER I = "	
30 INPUT I\$	Enter desired current (Example: 100mA = .1).
40 DISP "ENTER V = "	
50 INPUT V\$	Enter desired voltage (Example: 1V = 1).
60 OUTPUT 711;"R0F1X","I", I\$,"V",V\$,"X"	Output to IEEE bus, address 11.
70 GOTO 20	Repeat
80 END	

# HP 9825A

---

This program sets up the Model 228 output according to the values entered from the HP 9825 keyboard, using a 98034A HPIB interface and a 9872A extended I/O ROM.

## DIRECTIONS

1. Using Program 3, set the primary address of the Model 228 to 11.
2. Connect the Model 228 to the HP 9825A and the 98034A HPIB interface.
3. Enter the following program using the STORE key after each line is typed. Line numbers are automatically assigned by the 9825A.
4. Depress the RUN key.
5. The display will read "enter i = ?".
6. To program the Model 228 for 100mA, type .1 and press the CONTINUE key.
7. The display will read "enter v = ?".
8. To program the Model 228 for 1V, type 1 and press the CONTINUE key.
9. The programmed change can be verified by pressing the LOCAL key and using front panel controls to read the value.

## PROGRAM

## COMMENTS

---

0	dim A\$(20),I\$(20),V\$(20)	Dimension data strings.
1	dev"228",711	Define Model 228 address 11.
2	rem"228"	Set to remote.
3	ent"enter i = ?", I\$	Enter desired current. (Example: 100mA = .1)
4	ent"enter v = ?", V\$	Enter desired current. (Example: 1V = 1)
5	"228" → A\$	Set A\$ = "228"
6	wrt A\$, "ROF1X", "I", I\$, "V", V\$, "X"	Output to IEEE bus, address 11.
7	gto 2	Repeat
8	end	

---

# HP 9816

---

This program sets up the Model 228 output according to the values entered from the HP 9816 keyboard, using the 82937A GPIB interface and the 98611A Opt 650 BASIC system floppy disc.

## DIRECTIONS

1. Using Program 3, set the primary address of the Model 228 to 11.
2. With the power off, connect the Model 228 to the HP 9816 and HP 82937A GPIB interface.
3. Insert the 98611A Opt 650 BASIC system floppy disc into the disk drive.
4. Type EDIT and press the EXEC key.
5. Enter the following program using the ENTER key after each line is typed.
6. Press the HP 9816 RUN key.
7. The display will read "ENTER I =".
8. To program the Model 228 for 100mA, type .1 and press the ENTER key.
9. The display will read "ENTER V =".
10. To program the Model 228 for 1V, type 1 and press the ENTER key.
11. The programmed change can be verified by pressing the LOCAL key and using front panel controls to read the value.

## PROGRAM

## COMMENTS

---

10 REMOTE 711	Set to remote.
20 INPUT"ENTER I = ",I\$	Enter desired current (Example: 100mA = .1).
30 INPUT"ENTER V = ",V\$	Enter desired voltage (Example: 1V = 1).
40 OUTPUT 711;"R0F1X";"1";I\$; "V";V\$;"X"	Output to IEEE bus, address 11.
50 GOTO 20	
60 END	

---

# DEC LSI 11

---

This program sets up the Model 228 to output according to the values entered from the DEC LSI 11. The LSI 11 must be configured with 16k words of RAM and an IBV 11 IEEE interface. The software must be configured with IB software as well as FORTRAN and the RT 11 operating system.

## DIRECTIONS

1. Using Program 3, set the primary address of the Model 228 to 11.
2. Connect the Model 228 to the IBV 11 IEEE cable.
3. Enter the following program, using the editor under RT 11 and the name IPHILD.
4. Compile using the fortran compiler as follows: FORTRAN IPHILD.
5. Link with the system and IB libraries as follows: LINK IPHILD,IBLIB.
6. Type RUN IPHILD and depress the RETURN key.
7. The display will read "ENTER ADDRESS".
8. Type in 11 and depress the RETURN key.
9. The display will read "ENTER I = ".
10. To program the Model 228 for 100mA, type I100E-3F1X and press the RETURN key.

**PROGRAM****COMMENTS**

---

```
INTEGER*2 PRIADR
LOGICAL*1MSG(80),INPUT(80)
DO 2 I = 1,10
CALL IBSTER(I,O)           !Turn off IB errors.
2 CONTINUE
CALL IBSTER (15,5)         !Allow 5 error 15's.
CALL IBTIMO (120)         !Allow 1 second bus
                           !timeout.
CALL IBTERM ("10)         !Set LF as terminator.
CALL IBREN                 !Turn remote on.
4 TYPE 5
5 FORMAT (1X,'ENTER ADDRESS',%) !Input the address 11.
ACCEPT 10, PRIADR
10 FORMAT (2I4)
12 TYPE 15
15 FORMAT (1X,'ENTER I =',%) !Prompt for desired I.
CALL GETSTR (5,MSG,72)     !Get the test setup.
CALL IBSEOI (MSG, --1,PRIADR) !Program the 228.
18 I=IBRECV (INPUT,80,PRIADR)
INPUT (I + 1) = 0
CALL PUTSTR (7,INPUT,'0')
CALL (BUNT                 !Untalk the 228.
GO TO 12                   !Repeat
END
```

---

# PET/CBM 2001

---

This program sets up the Model 228 to the values entered from the PET/CBM 2001 keyboard.

## DIRECTIONS

1. Using Program 3, set the primary address of the Model 228 to 11.
2. Connect the Model 228 to the PET/CBM 2001 IEEE interface.
3. Enter the following program using the RETURN key after each line.
4. Type RUN and depress the RETURN key.
5. The display will read "ENTER I".
6. To program the Model 228 for 100mA, type .1 and press the RETURN key.
7. The display will read "ENTER V".
8. To program the Model 228 for 1V, type 1 and press the RETURN key.
9. The programmed change can be verified by pressing the LOCAL key and using front panel controls to read the value.

PROGRAM	COMMENTS
10 OPEN 6,11	Open file 6, primary address 11.
20 INPUT "ENTER I";I\$	Enter desired current (Example: 100mA = .1).
30 INPUT "ENTER V";V\$	Enter desired voltage (Example: 1V = 1).
40 PRINT#6,"R0F1X","I",I\$, "V",V\$,"X"	
50 GOTO 20	
60 END	





**KETHLEY**

Test Instrumentation Group  
28775 Aurora Road / Cleveland, Ohio 44139

---